

Shift Chain - Skid type



>> General information

Item	Value
Material	CPS-Amid(PA6+GF), RoHs
Speed	3m/s
Acceleration	10m/s ²
Temperature	-30°C ~ +130°C
Certificate	CE, ATEX(Ex)

>> Calculation table

Item	Value
Length of Cable Chain	$L = \frac{1}{2} \times LS + LP$
Bending Radius	
The biggest Cable inserted	Multiply 8~10 and the biggest cable
The biggest Hydraulic Hose inserted	Multiply 15~20 and the biggest hose

>> Dimension table

Shift Chain S Type	Pitch	Bending Radius (R)	Weight kg/m	Speed m/s	Temperature °C	Size				Frame type	Section Composition	
						A	B	C	D			
ST 044S	44	70, 90, 120, 150	1.03	3	-30 ~ +130	74	35	38,5	100	26		
			1.08			89	50					
			1.10			94	55					
			1.17			114	75					
			1.26			139	100					
			1.40			164	125					
			1.52			189	150					
			1.81			214	175					
			1.98			239	200					

(Dimensions in mm)

>> Ordering

ST 044S. 100. R120 / F - 1500L : 10ST

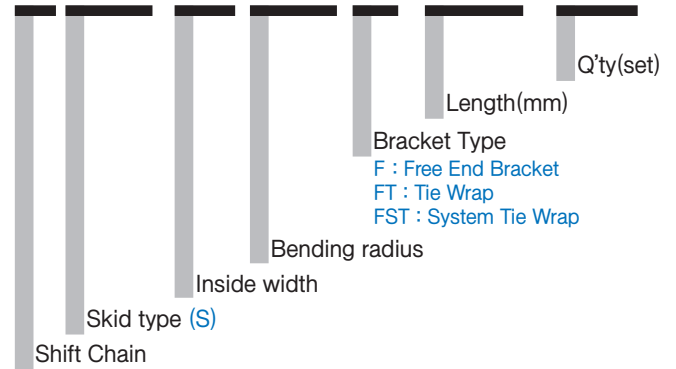

>> Bracket type

- ST044

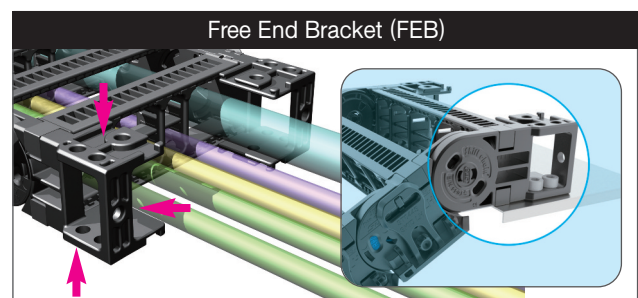

» Part list of Shift Chain Skid type

- Composition of Cable chain(Standard)
= Side band(RH) + Frame + Side band(LH) + Bending radius Unit + Free end bracket
- M divider(normal divider) should be applied every second frames to make a section composition.
- ※ Please refer to below part list and description to understand composition of cable chain.

Model	Classification	Part number	Description
ST044S	SIDE BAND	ST-SB044S(LH) ST-SB044S(RH)	Left side band of ST044S Right side band of ST044S
	BENDING RADIUS	ST-BRS044,R70,90,120,150	Bending radius unit for side band
	SKID	ST-SK044S(LH) ST-SK044S(RH)	Skid for long travel(Applied to side band)
	FRAME FRAME(UP)	sb-FR/M.35 sb-FR/M.50 sb-FR/M.55 sb-FR/M.75 sb-FR/M.100 sb-FR/M.125 sb-FR/M.150 sb-FR/M.175 sb-FR/M.200	Frame, 35mm Frame, 50mm Frame, 55mm Frame, 75mm Frame, 100mm Frame, 125mm Frame, 150mm Frame, 175mm Frame, 200mm
	FREE END BRACKET	End bracket of ST044S	End bracket of ST044S
	DIVIDER	sb-DV028/M sb-DV028/S	Normal divider To fix separators at the both side section
	SEPARATOR	S-SP/M.35 S-SP/M.50 S-SP/M.75 S-SP/M.100 S-SP/M.125 S-SP/M.150 S-SP/M.175 S-SP/M.200	Separator, 35mm Separator, 50mm Separator, 75mm Separator, 100mm Separator, 125mm Separator, 150mm Separator, 175mm Separator, 200mm
	TIE WRAP	S-TW036/025CR,35 S-TW036/025CR,55 S-TW036/025CR,75 S-TW036/025CR,100 S-TW036/025CR,125	Tie wrap for end bracket to fix cables, 35mm Tie wrap for end bracket to fix cables, 55mm Tie wrap for end bracket to fix cables, 75mm Tie wrap for end bracket to fix cables, 100mm Tie wrap for end bracket to fix cables, 125mm
	SYSTEM TIE WRAP	sb-DV028/W S-TWEB028	Divider for fixing cables at end bracket System tie wrap to arrange for cables right after moving bracket or fixing bracket

Shift Chain - Skid type

» Part of Shift Chain Skid type

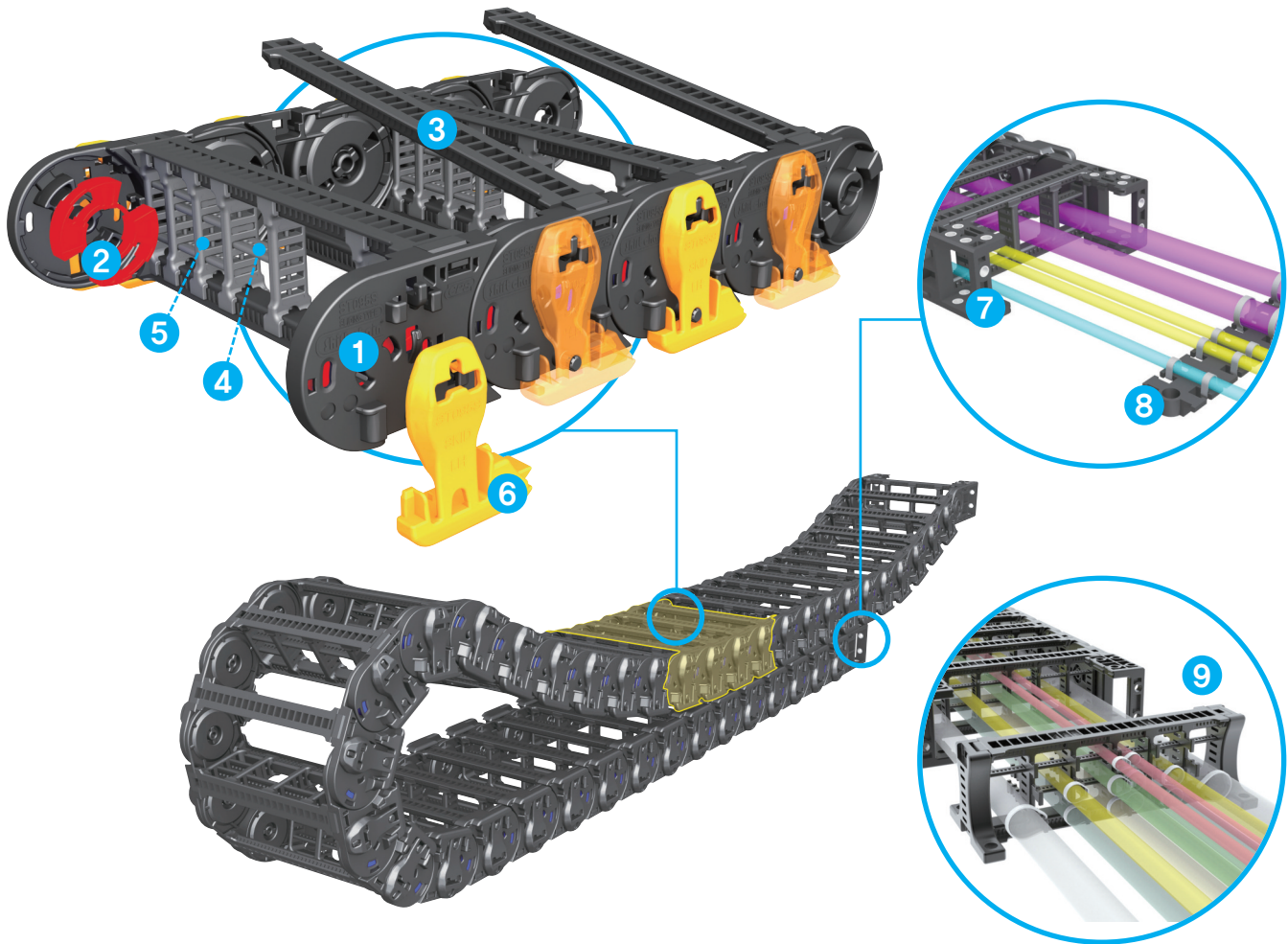

1 Side Band (SB)

A unit that connects each side band and between them BR is inserted to strengthen clamping force.

2 Bending Radius Unit (BR)

A unit that inserted between each side band. There are 6 supporting points to create durability.

5 Frame (Hinged Type) (FR)

Hinged-type frame, open one side, supports connection of both side of side band and have tongue and groove system plate to secure the position of the divider on the frame.

4 Separator (SP)

A unit that divides inserted cables vertically to prevent twisting and breaking problem.

5 Divider (DV-S, M, R, T)

A unit that divides inserted cables horizontally.

6 Skid

A unit that minimizes friction between upper and lower cable chain.

7 Free End Bracket (FEB)

A unit that connects at last side band (left&right). It can be fixed stronger using steel washers.

8 Tie Wrap (TW)

A unit that ties cables to maintain straightness of them. It can be assembled to bracket directly or installed separately from bracket.

9 System Tie Wrap (STW)

System-Tie Wrap has to be assembled on fixing and moving point of bracket and can be assembled without any tie wrap plate. This tie wrap is used to stay the cables on several floors prevent the cables from being twisted and it can also be assemble without any tools or bolt. This tie wrap has two types, one is to assemble inside bracket the other one is outside.

» Assembly procedure of Shift Chain Skid type

Assembly procedure of Shift chain S-type is as follows. The assembling process of shift Chain S-type is like below and you must use rubber hammer with careful combination of Divider and Separator. (Disassembly process for repair and replacement are in reverse order)



1
Insert BR Unit into each Side Band.
(Side Band is divided into right and left side according to the direction.)

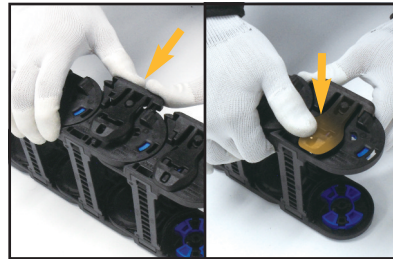

8
When inserting a Skid, push tightly to the home of Side Band until you hear "click"(Skid is divided each direction like right and left.)

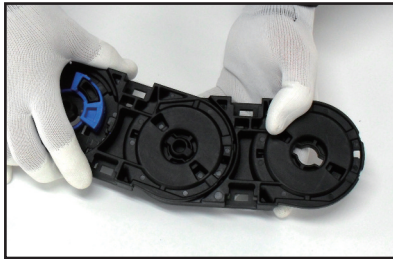

2
Continue to insert BR Unit into Side Band as you want to make it, Assemble Side Band which is inserted BR Unit as above.



9
Assemble the Skid on the entire connected Side Band as same way.



3
Continue to connect each Side Band as long as you want to make it. Connect the Side Band as many as you need.

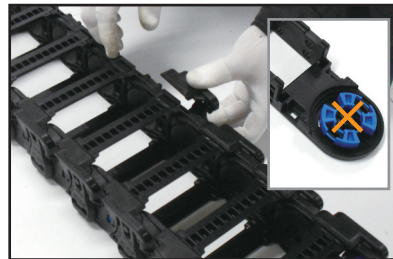

10
Assemble the Skid on the entire connected opposite side as well. Do not insert a BR Unit to M,FEB, (M,FEB will be making a turn to up and down)



4
Connect right and left link with specified frame.
(Put Hinge Type frame in the hole of Side Band)

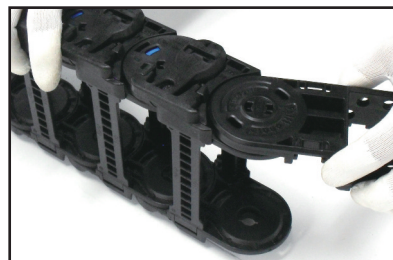

11
Assemble M,FEB to be corrective each direction such as right and left.

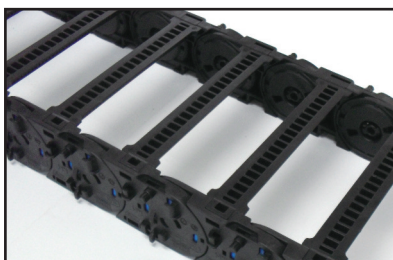

5
Insert frame pin onto connected each Frame and side of Side Band to be made tightly. (To divide inner room, insert divider which is connected with separator.



12
Assemble F,FEB to be suitable each direction such as right and left. (Do not insert a BR Unit for the Side Band which is connected with F,FEB)



6
Assemble opposite frame as same procedure.

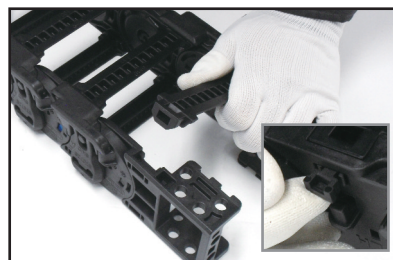

13
Assemble a specified frame in M,FEB and F,FEB. (Hinge is inserted into RH direction of FEB) Insert Frame pin into connected frame and side of FEB.



7
Insert Skid to the protruding side of Side Band.

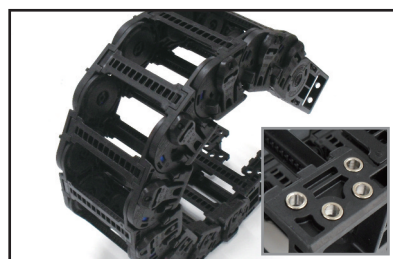

14
Insert steel washers into FEB according to fixing direction.

ST 044S

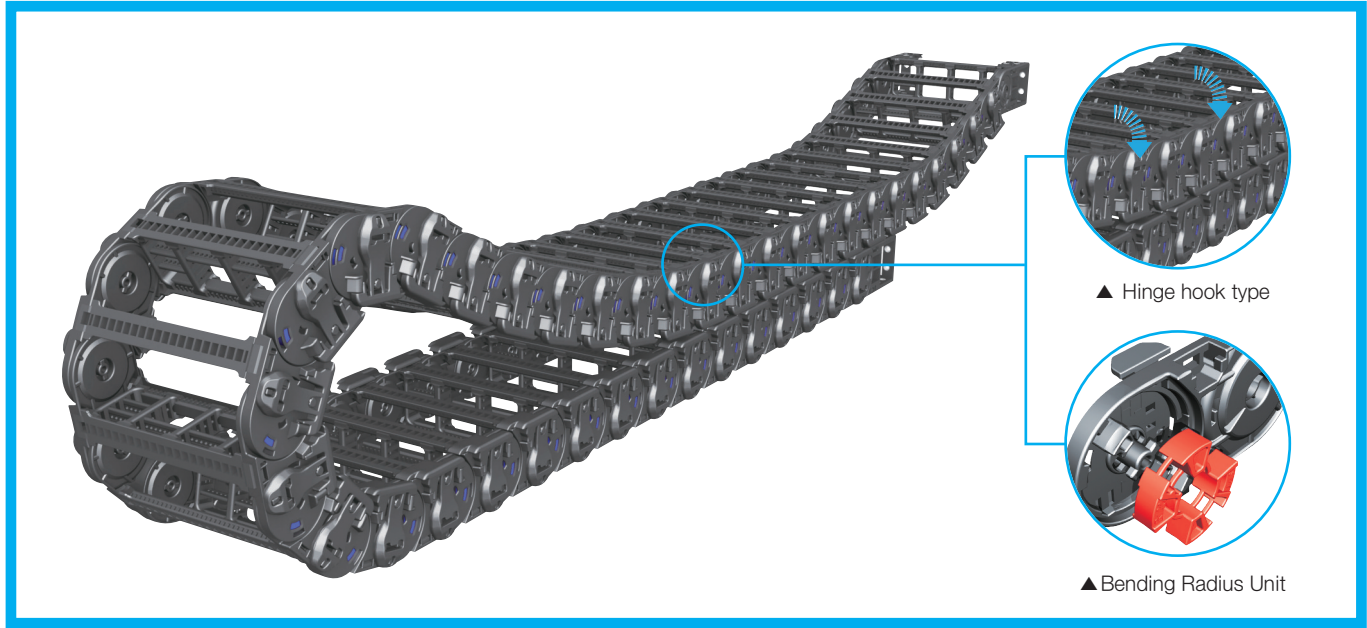

Layout of the chain

Ls: Stroke

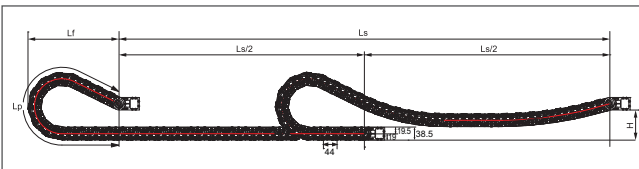

Bending Radius (R)	Lp Loop Length	Lf Loof Projection	H Moving Height
70	544	249	110
90	662	289	
120	926	393	
150	1,190	497	

(Dimensions in mm)

Chain cross section

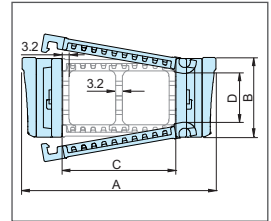
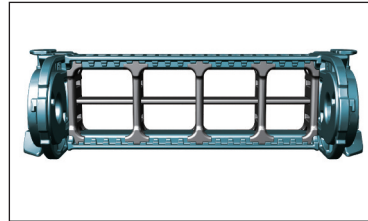

Chain Type	A Width(Outer)	B Height(Outer)	C Frame	D Height(Inner)	Weight kg/m
ST 044S	74	38,5	35	26	1,03
	89		50		1,08
	94		55		1,10
	114		75		1,17
	139		100		1,26
	164		125		1,40
	189		150		1,52
	214		175		1,81
239	200	1,98			

(Dimensions in mm)

Dividers(DV)

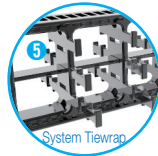
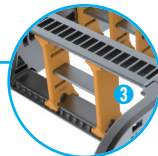
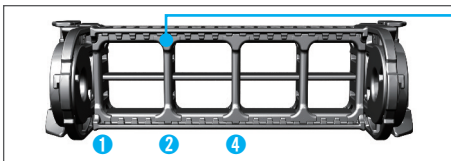

Assemble divider every second frame.
 DV.T : Applied to Frame 125~200.
 DV.M : Normal Divider.
 DV.W : Applicable to System Tie Wrap or FEB.

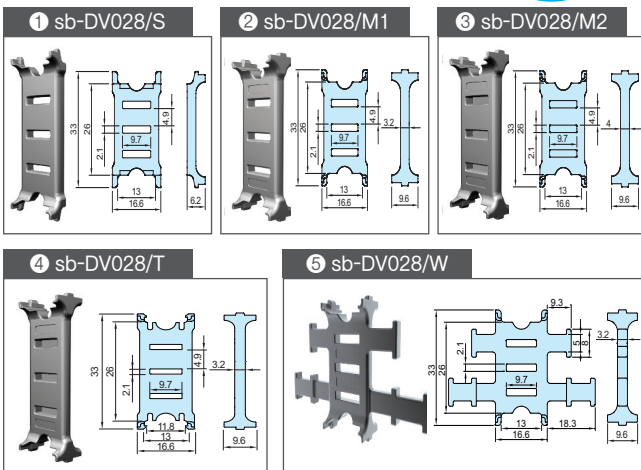

(Dimensions in mm)

Separators(SP)

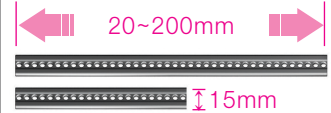
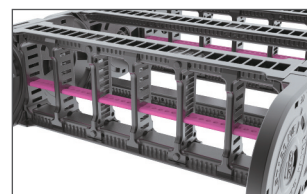

Chain Type	Ordering NO.	Frame
ST 044S	S-SP/M,35	35
	S-SP/M,50	50
	S-SP/M,55	55
	S-SP/M,75	75
	S-SP/M,100	100
	S-SP/M,125	125
	S-SP/M,150	150
	S-SP/M,175	175
S-SP/M,200	200	

(Dimensions in mm)

Free end bracket

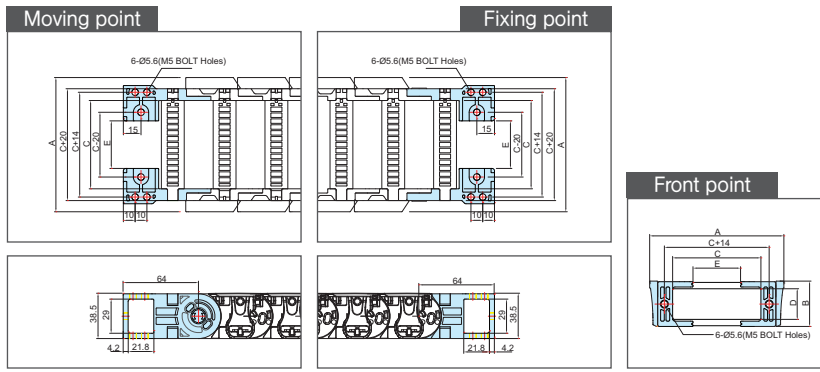

Chain Type	A Width(Outer)	B Height(Outer)	C Frame	D Height(Inner)	E M,EB Bolt hole width	Hole Type
ST 044S	74	38,5	35	26	0,4	M5 Bolt Holes
	89		50		15,4	
	94		55		20,4	
	114		75		40,4	
	139		100		65,4	
	164		125		90,4	
	189		150		115,4	
	214		175		140,4	
	239		200		165,4	

(Dimensions in mm)

System tie wrap (STW)

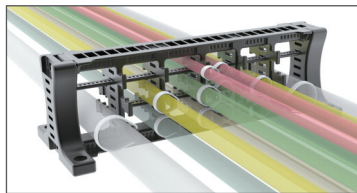

It is a unit to classify each cable for preventing entanglement of cables. It can either be installed to free end bracket or installed separately according its application environment.

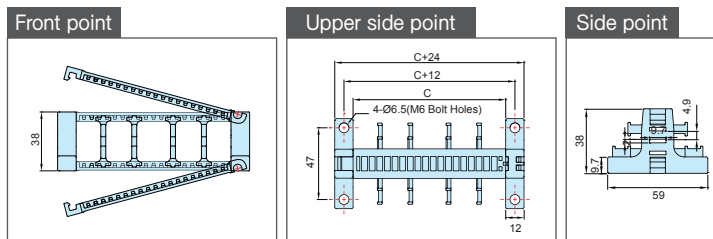

Chain Type	Ordering No.	C Frame	Hole Type
ST 044S	S-TW,EB028,35	35	M6 Bolt Holes
	S-TW,EB028,50	50	
	S-TW,EB028,55	55	
	S-TW,EB028,75	75	
	S-TW,EB028,100	100	
	S-TW,EB028,125	125	
	S-TW,EB028,150	150	
	S-TW,EB028,175	175	
	S-TW,EB028,200	200	

(Dimensions in mm)

Tie wrap (TW)

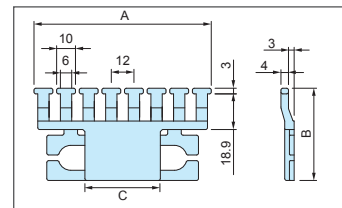
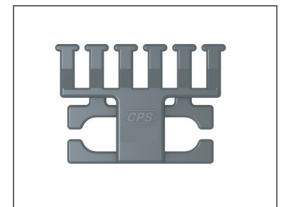
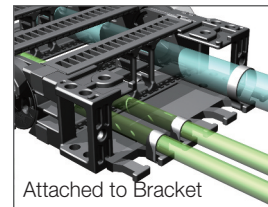

Chain Type	Ordering No.	A	B	C
ST 044S	S-TW036/025CR,35	46	35,4	-
	S-TW036/025CR,50	69	48,9	15
	S-TW036/025CR,55	70	48,9	20
	S-TW036/025CR,75	94	48,9	40
	S-TW036/025CR,100	118	48,9	65
	S-TW036/025CR,125	142	48,9	90

(Dimensions in mm)

Guide channel

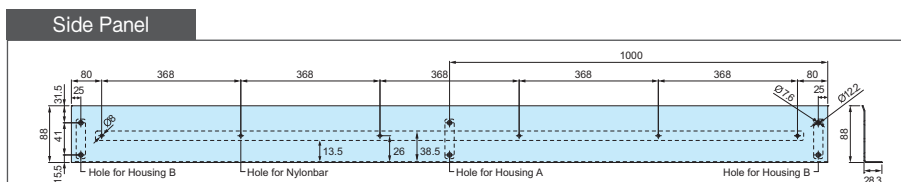
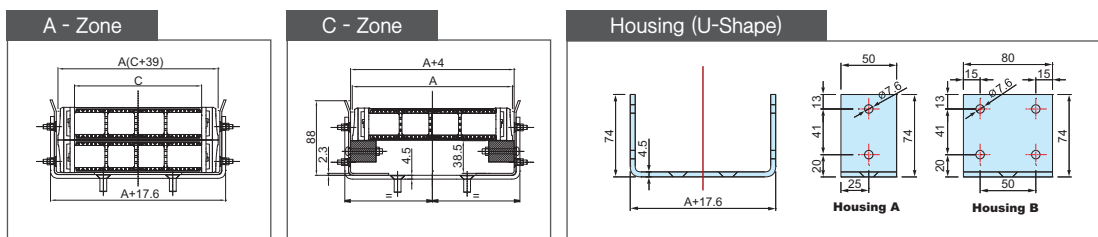

(Dimensions in mm)