

Tipo / Type  
3F

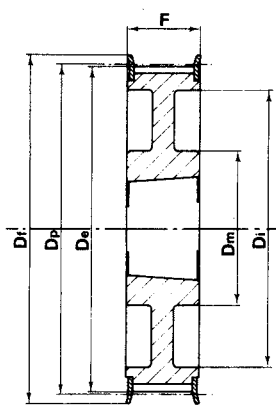

Tipo / Type  
3WF

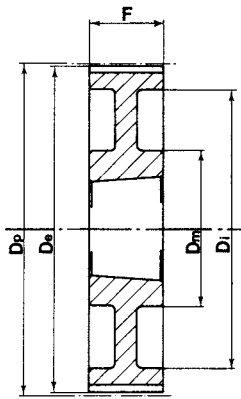

Tipo / Type  
3W

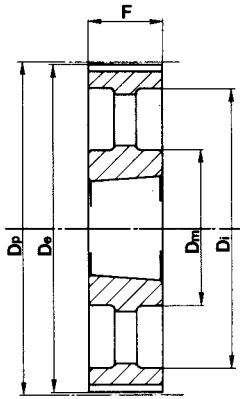

Tipo / Type  
3A

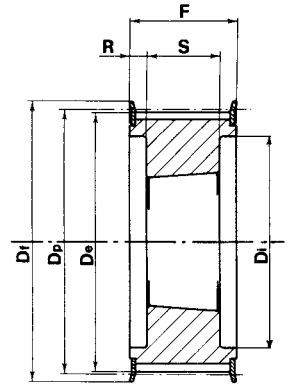

Tipo / Type  
4F

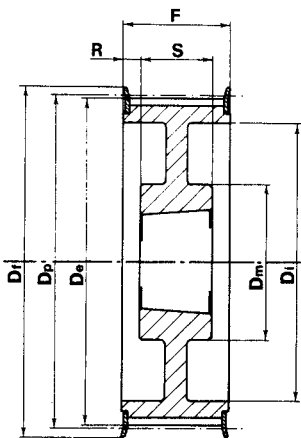

Tipo / Type  
4WF

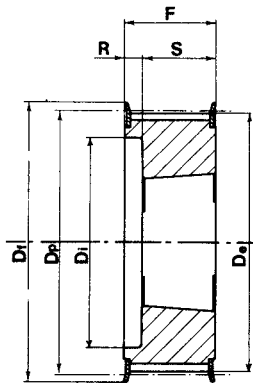

Tipo / Type  
5F

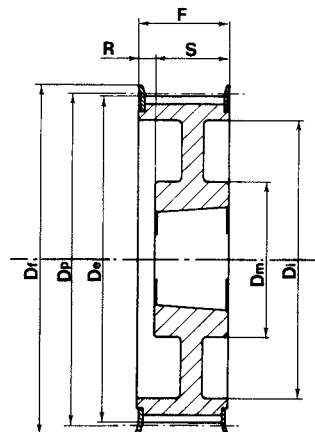

Tipo / Type  
5WF

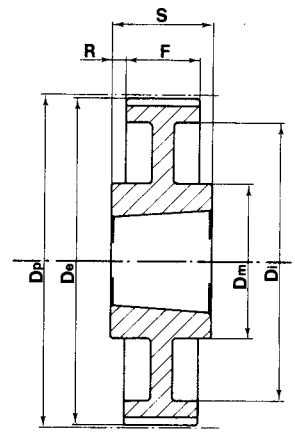

Tipo / Type  
7W

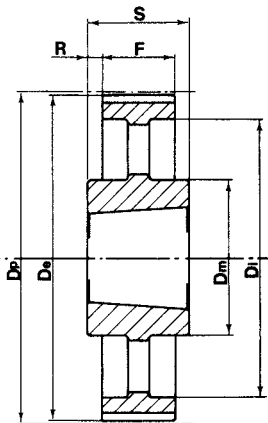

Tipo / Type  
7A

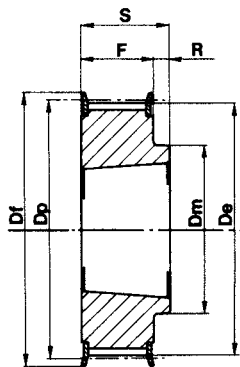

Tipo / Type  
8F

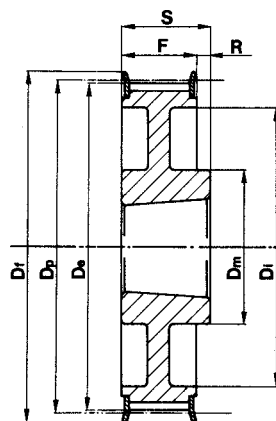

Tipo / Type  
8WF

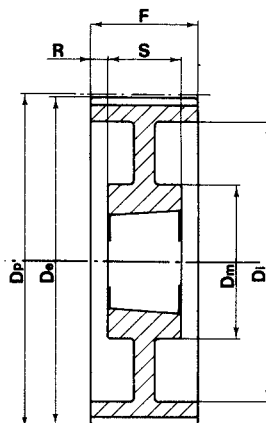

Tipo / Type  
9W

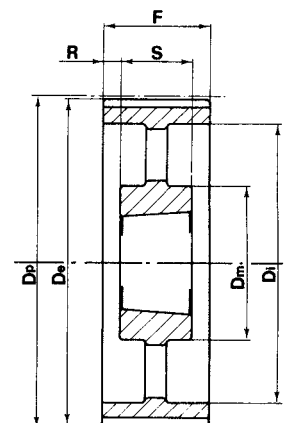

Tipo / Type  
9A

**Pulegge dentate per bussola conica / Timing belt pulleys for taper bushes**  
**Zahnriemenscheiben für Spannbüchsen / Poulies dentées à moyeu amovible**  
**Poleas dentadas para casquillos cónicos (taper)**



**H 100 - 1/2" (12,7 mm)**

Caratteristiche Features Merkmale Características	Codice Code symbol Fabriknummer Code symbole Numero de fabrica	Nostro codice Our code Unser kode Notre code Nuestro codiglo	Tipo Type Typ Type Tipo	Codice flangia Flange code Bordscheiben-Code Code flasque Código brida	Bussola Bush Buchse Moyeu Casquillo	Foro max. Max. Bore Max. Bohrung Alesage max. Agujero max.	Dp	De	Df	Dm	Di	F	S	R	Peso Weight / Gewicht Poids / Peso Kg	
Acciaio / Steel / Stahl Acier / Acero	con flangia / with flanges mit Flanges / avec flasques / con tapetas	<b>16H100</b>	<b>TH10016</b>	5F	FL061	1108	28	64,68	63,31	70,0	-	45	31,0	22,0	9,0	0,4
		<b>18H100</b>	<b>TH10018</b>	5F	FL063	1210	32	72,77	71,39	79,0	-	52	31,0	25,0	6,0	0,5
		<b>19H100</b>	<b>TH10019</b>	5F	FL064	1210	32	76,81	75,44	82,5	-	56	31,0	25,0	6,0	0,6
		<b>20H100</b>	<b>TH10020</b>	5F	FL076	1210	32	80,55	79,48	87,0	-	60	31,0	25,0	6,0	0,7
		<b>21H100</b>	<b>TH10021</b>	5F	FL066	1210	32	84,89	83,52	91,0	-	64	32,0	25,0	7,0	0,8
		<b>22H100</b>	<b>TH10022</b>	5F	FL067	1210	32	88,94	87,56	94,0	-	67	32,0	25,0	7,0	0,9
		<b>23H100</b>	<b>TH10023</b>	5F	FL068	1610	42	92,98	91,61	97,0	-	70	32,0	25,0	7,0	0,9
		<b>24H100</b>	<b>TH10024</b>	5F	FL070	1610	42	97,02	95,65	102,0	-	74	32,0	25,0	7,0	1,0
		<b>25H100</b>	<b>TH10025</b>	5F	FL071	1610	42	101,06	99,69	106,0	-	77	32,0	25,0	7,0	1,0
		<b>26H100</b>	<b>TH10026</b>	5F	FL072	1610	42	105,11	103,73	112,0	-	82	32,0	25,0	7,0	1,2
		<b>27H100</b>	<b>TH10027</b>	5F	FL074	1610	42	109,15	107,78	115,0	-	85	32,0	25,0	7,0	1,3
		<b>28H100</b>	<b>TH10028</b>	5F	FL075	1610	42	113,19	111,82	120,0	-	90	32,0	25,0	7,0	1,5
		<b>30H100</b>	<b>TH10030</b>	5F	FL078	1610	42	121,28	119,90	128,0	-	98	32,0	25,0	7,0	1,7
		<b>32H100</b>	<b>TH10032</b>	5WF	FL080	1610	42	129,36	127,99	135,0	80	106	32,0	25,0	7,0	2,0
		<b>36H100</b>	<b>TH10036</b>	5WF	FL085	1610	42	145,53	144,16	150,0	92	121	32,0	25,0	7,0	2,7
		<b>40H100</b>	<b>TH10040</b>	5WF	FL090	1610	42	161,70	160,33	168,0	92	138	32,0	25,0	7,0	3,6
<b>44H100</b>	<b>TH10044</b>	3WF	FL095	2012	50	177,87	176,50	184,0	106	152	32,0	32,0	-	3,8		
<b>48H100</b>	<b>TH10048</b>	3WF	FL100	2012	50	194,04	192,67	200,0	106	169	32,0	32,0	-	3,2		
Ghisa / Cast iron Grauguss / Fonte Hierro fundido	senza flangia without flanges ohne Flanschen sans flasques sin tapetas	<b>60H100</b>	<b>TH10060</b>	9A	-	2012	50	242,55	241,18	-	92	223	34,0	32,0	1,0	4,8
		<b>72H100</b>	<b>TH10072</b>	9A	-	2012	50	291,06	289,69	-	92	270	34,0	32,0	1,0	5,7
		<b>84H100</b>	<b>TH10084</b>	9A	-	2012	50	339,57	338,20	-	92	318	34,0	32,0	1,0	6,8
		<b>96H100</b>	<b>TH10096</b>	7A	-	2517	60	388,08	386,71	-	106	366	34,0	45,0	5,5	8,2
		<b>120H100</b>	<b>TH10120</b>	7A	-	2517	60	485,10	483,73	-	106	462	34,0	45,0	5,5	12,1

**H 150 - 1/2" (12,7 mm)**

Caratteristiche Features Merkmale Características	Codice Code symbol Fabriknummer Code symbole Numero de fabrica	Nostro codice Our code Unser kode Notre code Nuestro codiglo	Tipo Type Typ Type Tipo	Codice flangia Flange code Bordscheiben-Code Code flasque Código brida	Bussola Bush Buchse Moyeu Casquillo	Foro max. Max. Bore Max. Bohrung Alesage max. Agujero max.	Dp	De	Df	Dm	Di	F	S	R	Peso Weight / Gewicht Poids / Peso Kg	
Acciaio / Steel / Stahl Acier / Acero	con flangia / with flanges mit Flanges / avec flasques / con tapetas	<b>18H150</b>	<b>TH15018</b>	5F	FL063	1210	32	72,77	71,39	79,0	-	52	45,0	25,0	20,0	0,6
		<b>19H150</b>	<b>TH15019</b>	5F	FL064	1210	32	76,81	75,44	82,5	-	56	45,0	25,0	20,0	0,7
		<b>20H150</b>	<b>TH15020</b>	5F	FL076	1210	32	80,55	79,48	87,0	-	60	45,0	25,0	20,0	0,8
		<b>21H150</b>	<b>TH15021</b>	5F	FL066	1210	32	84,89	83,52	91,0	-	64	45,0	25,0	20,0	1,0
		<b>22H150</b>	<b>TH15022</b>	5F	FL067	1210	32	88,94	87,56	94,0	-	67	45,0	25,0	20,0	1,2
		<b>23H150</b>	<b>TH15023</b>	5F	FL068	1610	42	92,98	91,61	97,0	-	70	45,0	25,0	20,0	1,3
		<b>24H150</b>	<b>TH15024</b>	5F	FL070	1610	42	97,02	95,65	102,0	-	74	45,0	25,0	20,0	1,0
		<b>25H150</b>	<b>TH15025</b>	5F	FL071	1610	42	101,06	99,69	106,0	-	77	45,0	25,0	20,0	1,2
		<b>26H150</b>	<b>TH15026</b>	5F	FL072	1610	42	105,11	103,73	112,0	-	82	45,0	25,0	20,0	1,4
		<b>27H150</b>	<b>TH15027</b>	5F	FL074	1610	42	109,15	107,78	115,0	-	85	45,0	25,0	20,0	1,6
		<b>28H150</b>	<b>TH15028</b>	5F	FL075	1610	42	113,19	111,82	120,0	-	90	45,0	25,0	20,0	1,8
		<b>30H150</b>	<b>TH15030</b>	5F	FL078	1610	42	121,28	119,90	128,0	-	98	45,0	25,0	20,0	2,3
		<b>32H150</b>	<b>TH15032</b>	5WF	FL080	1610	42	129,36	127,99	135,0	80	106	45,0	25,0	20,0	2,3
		<b>36H150</b>	<b>TH15036</b>	5WF	FL085	1610	42	145,53	144,16	150,0	92	121	45,0	25,0	20,0	3,1
		<b>40H150</b>	<b>TH15040</b>	5WF	FL090	1610	42	161,70	160,33	168,0	92	138	45,0	25,0	20,0	4,0
		<b>44H150</b>	<b>TH15044</b>	5WF	FL095	2012	50	177,87	176,50	184,0	106	152	45,0	32,0	13,0	4,4
<b>48H150</b>	<b>TH15048</b>	5WF	FL100	2012	50	194,04	192,67	200,0	106	169	45,0	32,0	13,0	4,8		
Ghisa / Cast iron Grauguss / Fonte Hierro fundido	senza flangia without flanges ohne Flanschen sans flasques sin tapetas	<b>60H150</b>	<b>TH15060</b>	9A	-	2012	50	242,55	241,18	-	92	223	46,0	32,0	7,5	5,4
		<b>72H150</b>	<b>TH15072</b>	9A	-	2012	50	291,06	289,69	-	92	270	46,0	32,0	7,5	6,5
		<b>84H150</b>	<b>TH15084</b>	9A	-	2012	50	339,57	338,20	-	92	318	46,0	32,0	7,5	8,4
		<b>96H150</b>	<b>TH15096</b>	9A	-	2517	60	388,08	386,71	-	106	366	46,0	45,0	0,5	11,0
		<b>120H150</b>	<b>TH73120</b>	9A	-	2517	60	485,10	483,73	-	106	462	46,0	45,0	0,5	14,8

**Pulegge dentate per bussola conica / Timing belt pulleys for taper bushes**  
**Zahnriemenscheiben für Spannbüchsen / Poulies dentées à moyeu amovible**  
**Poleas dentadas para casquillos cónicos (taper)**

**H 200 - 1/2" (12,7 mm)**

Caratteristiche Features Merkmal Características	Codice Code symbol Fabriknummer Code symbole Numero de fabrica	Nostro codice Our code Unser kode Notre code Nuestro codiglo	Tipo Type Typ Type Tipo	Codice flangia Flange code Bordscheiben-Code Code flasque Código brida	Bussola Bush Buchse Moyeu Casquillo	Foro max. Max. Bore Max. Bohrung Alesage max. Agujero max.	Dp	De	Df	Dm	Di	F	S	R	Peso Weight / Gewicht Poids / Peso Kg	
Acciaio / Steel / Stahl Acier / Acero	con flangia / with flanges mit Flanges / avec flasques / con tapetas	<b>18H200</b>	<b>TH20018</b>	5F	FL063	1210	32	72,77	71,39	79,0	-	52	58,0	25,0	33,0	0,8
		<b>19H200</b>	<b>TH20019</b>	5F	FL064	1210	32	76,81	75,44	82,5	-	56	58,0	25,0	33,0	0,9
		<b>20H200</b>	<b>TH20020</b>	5F	FL076	1610	42	80,55	79,48	87,0	-	60	58,0	25,0	33,0	1,0
		<b>21H200</b>	<b>TH20021</b>	5F	FL066	1610	42	84,89	83,52	91,0	-	64	58,0	25,0	33,0	1,7
		<b>22H200</b>	<b>TH20022</b>	5F	FL067	1610	42	88,94	87,56	94,0	-	67	58,0	25,0	33,0	1,5
		<b>23H200</b>	<b>TH20023</b>	5F	FL068	1610	42	92,98	91,61	97,0	-	70	58,0	25,0	33,0	1,8
		<b>24H200</b>	<b>TH20024</b>	5F	FL070	1610	42	97,02	95,65	102,0	-	74	58,0	25,0	33,0	1,5
		<b>25H200</b>	<b>TH20025</b>	5F	FL071	1610	42	101,06	99,69	106,0	-	77	58,0	25,0	33,0	1,5
		<b>26H200</b>	<b>TH20026</b>	5F	FL072	1610	42	105,11	103,73	112,0	-	82	58,0	25,0	33,0	1,8
		<b>27H200</b>	<b>TH20027</b>	5F	FL074	1610	42	109,15	107,78	115,0	-	85	58,0	25,0	33,0	1,9
		<b>28H200</b>	<b>TH20028</b>	5F	FL075	1610	42	113,19	111,82	120,0	-	90	58,0	25,0	33,0	1,9
		<b>30H200</b>	<b>TH20030</b>	5F	FL078	1610	42	121,28	119,90	128,0	-	98	58,0	25,0	33,0	2,3
		<b>32H200</b>	<b>TH20032</b>	5F	FL080	2012	50	129,36	127,99	135,0	-	106	58,0	32,0	26,0	3,0
		<b>36H200</b>	<b>TH20036</b>	5WF	FL085	2012	50	145,53	144,16	150,0	102	121	58,0	32,0	26,0	3,0
		<b>40H200</b>	<b>TH20040</b>	5WF	FL090	2012	50	161,70	160,33	168,0	106	138	58,0	32,0	26,0	3,6
<b>44H200</b>	<b>TH20044</b>	5WF	FL095	2012	50	177,87	176,50	184,0	106	152	58,0	32,0	26,0	4,0		
<b>48H200</b>	<b>TH20048</b>	5WF	FL100	2517	60	194,04	192,67	200,0	119	169	58,0	45,0	13,0	4,6		
Ghisa / Cast iron Grauguss / Fonte Hierro fundido	senza flangia without flanges ohne Flanschen sans flasques sin tapetas	<b>60H200</b>	<b>TH20060</b>	9A	-	2517	60	242,55	241,18	-	119	223	60,0	45,0	7,5	7,0
		<b>72H200</b>	<b>TH20072</b>	9A	-	2517	60	291,06	289,69	-	119	270	60,0	45,0	7,5	8,0
		<b>84H200</b>	<b>TH20084</b>	9A	-	2517	60	339,57	338,20	-	119	318	60,0	45,0	7,5	9,0
		<b>96H200</b>	<b>TH20096</b>	9A	-	2517	60	388,08	386,71	-	119	366	60,0	45,0	7,5	10,0
		<b>120H200</b>	<b>TH20120</b>	9A	-	2517	60	485,10	483,73	-	119	462	60,0	45,0	7,5	13,4

**H 300 - 1/2" (12,7 mm)**

Caratteristiche Features Merkmal Características	Codice Code symbol Fabriknummer Code symbole Numero de fabrica	Nostro codice Our code Unser kode Notre code Nuestro codiglo	Tipo Type Typ Type Tipo	Codice flangia Flange code Bordscheiben-Code Code flasque Código brida	Bussola Bush Buchse Moyeu Casquillo	Foro max. Max. Bore Max. Bohrung Alesage max. Agujero max.	Dp	De	Df	Dm	Di	F	S	R	Peso Weight / Gewicht Poids / Peso Kg	
Acciaio / Steel / Stahl Acier / Acero	con flangia / with flanges mit Flanges / avec flasques / con tapetas	<b>20H300</b>	<b>TH30020</b>	4F	FL076	1615	42	80,85	79,48	87,0	-	60	84,0	38,0	23,0	1,5
		<b>21H300</b>	<b>TH30021</b>	4F	FL066	1615	42	84,89	83,52	91,0	-	64	84,0	38,0	23,0	1,2
		<b>22H300</b>	<b>TH30022</b>	4F	FL067	1615	42	88,94	87,56	94,0	-	67	84,0	38,0	23,0	1,6
		<b>23H300</b>	<b>TH30023</b>	4F	FL068	1615	42	92,98	91,61	97,0	-	70	84,0	38,0	23,0	1,8
		<b>24H300</b>	<b>TH30024</b>	4F	FL070	1615	42	97,02	95,65	102,0	-	74	84,0	38,0	23,0	2,0
		<b>25H300</b>	<b>TH30025</b>	4F	FL071	1615	42	101,06	99,69	106,0	-	77	84,0	38,0	23,0	2,0
		<b>26H300</b>	<b>TH30026</b>	4F	FL072	1615	42	105,11	103,73	112,0	-	82	84,0	38,0	23,0	2,7
		<b>27H300</b>	<b>TH30027</b>	4F	FL074	2012	50	109,15	107,78	115,0	-	85	84,0	32,0	26,0	3,0
		<b>28H300</b>	<b>TH30028</b>	4F	FL075	2012	50	113,19	111,82	120,0	-	90	84,0	32,0	26,0	2,4
		<b>30H300</b>	<b>TH30030</b>	4F	FL078	2012	50	121,28	119,90	128,0	-	98	84,0	32,0	26,0	2,9
		<b>32H300</b>	<b>TH30032</b>	4F	FL080	2517	60	129,36	127,99	135,0	-	106	84,0	45,0	19,5	3,3
		<b>36H300</b>	<b>TH30036</b>	4F	FL085	2517	60	145,53	144,16	150,0	-	121	84,0	45,0	19,5	4,5
		<b>40H300</b>	<b>TH30040</b>	4F	FL090	2517	60	161,70	160,33	168,0	-	138	84,0	45,0	19,5	6,0
		<b>44H300</b>	<b>TH30044</b>	9WF	FL095	2517	60	177,87	176,50	184,0	119	152	86,0	45,0	20,5	6,6
		<b>48H300</b>	<b>TH30048</b>	9WF	FL100	2517	60	194,04	192,67	200,0	119	169	86,0	45,0	20,5	7,6
Ghisa / Cast iron Grauguss / Fonte Hierro fundido	senza flangia without flanges ohne Flanschen sans flasques sin tapetas	<b>60H300</b>	<b>TH30060</b>	9A	-	2517	60	242,55	241,18	-	119	223	86,0	45,0	20,5	8,4
		<b>72H300</b>	<b>TH30072</b>	9A	-	2517	60	291,06	289,69	-	119	270	86,0	45,0	20,5	10,4
		<b>84H300</b>	<b>TH30084</b>	9A	-	2517	60	339,57	338,20	-	119	318	86,0	45,0	20,5	12,5
		<b>96H300</b>	<b>TH30096</b>	9A	-	3030	75	388,08	386,71	-	150	366	86,0	76,0	5,0	14,2
		<b>120H300</b>	<b>TH30120</b>	9A	-	3030	75	485,10	483,73	-	150	462	86,0	76,0	5,0	18,8